



**ABRABORO<sup>®</sup>**  
powertool accessories

W roku 2007 „LŁ” Spółka z ograniczoną odpowiedzialnością sp. k. (dawniej „Lange Łukaszuk” spółka jawna) nawiązała współpracę z wiodącym dystrybutorem wielu markowych narzędzi na rynku węgierskim - firmą ABRABORO. Nasz nowy partner stał się podstawowym dostawcą uniwersalnych szczotek technicznych jednego z doskonale znanych europejskich producentów. Produkty te, charakteryzujące się doskonałą relacją jakości do ceny, szybko zyskały uznanie naszych klientów.

To skłoniło firmę „LŁ” do rozszerzenia współpracy z ABRABORO. W efekcie, od jesieni 2008 roku jesteśmy także wyłącznym reprezentantem ABRABORO w zakresie wiertel do metalu, kamienia, betonu oraz drewna. Szeroki program różnych typów wiertel we wszelkich rozmiarach, wykonanych z najwyższą starannością, gwarantuje dalszy wzrost popularności marki na rynku polskim. Doskonała jakość oraz atrakcyjne ceny w połączeniu z profesjonalną obsługą ze strony „LŁ” stanowią gotową receptę na sukces.



**ABRABORO**<sup>®</sup>  
powertool accessories

Produkt menadżer:

**Adam Raczkowski** - tel. 71 39 80 872

[a.raczkowski@langelukaszuk.pl](mailto:a.raczkowski@langelukaszuk.pl)

## WIERTŁA HSS-R DIN 338, 118°, CZARNE

- opakowanie z tworzywa sztucznego
- **podana cena netto [zł] za 1 sztukę wiertła**
- Ø 0,3 - 10,0 mm - 10 sztuk w opakowaniu
- Ø 10,2 - 13,0 mm - 5 sztuk w opakowaniu
- Ø 13,5 i większe - 1 sztuka w opakowaniu

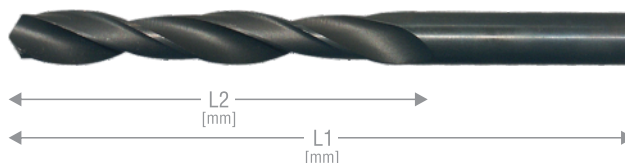

Nr artykułu	Ø / L1 / L2	Cena netto [zł]	Nr artykułu	Ø / L1 / L2	Cena netto [zł]	Nr artykułu	Ø / L1 / L2	Cena netto [zł]
AB00010030	0,3 / 19 / 2,5	0,72	AB00010430	4,3 / 80 / 47	1,37	AB00010830	8,3 / 117 / 75	5,43
AB00010040	0,4 / 20 / 5	0,72	AB00010440	4,4 / 80 / 47	1,37	AB00010840	8,4 / 117 / 75	5,43
AB00010050	0,5 / 22 / 6	0,72	AB00010450	4,5 / 80 / 47	1,10	AB00010850	8,5 / 117 / 75	3,03
AB00010060	0,6 / 24 / 7	0,72	AB00010460	4,6 / 80 / 47	1,67	AB00010860	8,6 / 125 / 81	6,47
AB00010070	0,7 / 29 / 9	0,72	AB00010470	4,7 / 80 / 47	1,67	AB00010870	8,7 / 125 / 81	6,47
AB00010080	0,8 / 30 / 10	0,72	AB00010480	4,8 / 86 / 52	1,15	AB00010880	8,8 / 125 / 81	6,47
AB00010090	0,9 / 32 / 11	0,72	AB00010490	4,9 / 86 / 52	1,67	AB00010890	8,9 / 125 / 81	6,47
AB00010100	1,0 / 34 / 12	0,52	AB00010500	5,0 / 86 / 52	1,15	AB00010900	9,0 / 125 / 81	3,86
AB00010110	1,1 / 36 / 14	0,78	AB00010510	5,1 / 86 / 52	2,09	AB00010910	9,1 / 125 / 81	7,12
AB00010120	1,2 / 38 / 16	0,78	AB00010520	5,2 / 86 / 52	1,36	AB00010920	9,2 / 125 / 81	7,12
AB00010130	1,3 / 38 / 16	0,78	AB00010530	5,3 / 86 / 52	2,09	AB00010930	9,3 / 125 / 81	7,12
AB00010140	1,4 / 40 / 18	0,78	AB00010540	5,4 / 93 / 57	2,09	AB00010940	9,4 / 125 / 81	7,12
AB00010150	1,5 / 40 / 18	0,52	AB00010550	5,5 / 93 / 57	1,36	AB00010950	9,5 / 125 / 81	4,28
AB00010160	1,6 / 43 / 20	0,88	AB00010560	5,6 / 93 / 57	2,40	AB00010960	9,6 / 133 / 87	7,62
AB00010170	1,7 / 43 / 20	0,88	AB00010570	5,7 / 93 / 57	2,44	AB00010970	9,7 / 133 / 87	7,62
AB00010180	1,8 / 46 / 22	0,88	AB00010580	5,8 / 93 / 57	2,44	AB00010980	9,8 / 133 / 87	7,62
AB00010190	1,9 / 46 / 22	0,88	AB00010590	5,9 / 93 / 57	2,44	AB00010990	9,9 / 133 / 87	7,62
AB00010200	2,0 / 49 / 24	0,63	AB00010600	6,0 / 93 / 57	1,51	AB00011000	10,0 / 133 / 87	4,49
AB00010210	2,1 / 49 / 24	0,95	AB00010610	6,1 / 101 / 63	2,82	AB00011020	10,2 / 133 / 87	7,39
AB00010220	2,2 / 53 / 27	0,95	AB00010620	6,2 / 101 / 63	2,82	AB00011050	10,5 / 133 / 87	4,55
AB00010230	2,3 / 53 / 27	0,95	AB00010630	6,3 / 101 / 63	2,82	AB00011100	11,0 / 142 / 94	5,55
AB00010240	2,4 / 57 / 30	0,95	AB00010640	6,4 / 101 / 63	2,82	AB00011150	11,5 / 142 / 94	5,99
AB00010250	2,5 / 57 / 30	0,63	AB00010650	6,5 / 101 / 63	1,77	AB00011200	12,0 / 151 / 101	6,49
AB00010260	2,6 / 57 / 30	1,00	AB00010660	6,6 / 101 / 63	3,44	AB00011250	12,5 / 151 / 101	6,69
AB00010270	2,7 / 61 / 33	1,00	AB00010670	6,7 / 101 / 63	3,44	AB00011300	13,0 / 151 / 101	7,39
AB00010280	2,8 / 61 / 33	1,00	AB00010680	6,8 / 109 / 69	3,44	AB00011350	13,5 / 160 / 108	19,39
AB00010290	2,9 / 61 / 33	1,00	AB00010690	6,9 / 109 / 69	3,44	AB00011400	14,0 / 160 / 108	19,99
AB00010300	3,0 / 61 / 33	0,75	AB00010700	7,0 / 109 / 69	1,77	AB00011450	14,5 / 169 / 114	22,99
AB00010310	3,1 / 65 / 36	1,04	AB00010710	7,1 / 109 / 69	3,90	AB00011500	15,0 / 169 / 114	23,50
AB00010320	3,2 / 65 / 36	0,86	AB00010720	7,2 / 109 / 69	3,90	AB00011550	15,5 / 178 / 120	29,00
AB00010330	3,3 / 65 / 36	0,86	AB00010730	7,3 / 109 / 69	3,90	AB00011600	16,0 / 178 / 120	29,00
AB00010340	3,4 / 70 / 39	1,07	AB00010740	7,4 / 109 / 69	3,90	AB00011650	16,5 / 184 / 125	32,70
AB00010350	3,5 / 70 / 39	0,86	AB00010750	7,5 / 109 / 69	2,30	AB00011700	17,0 / 184 / 125	32,70
AB00010360	3,6 / 70 / 39	1,07	AB00010760	7,6 / 117 / 75	4,64	AB00011750	17,5 / 191 / 130	37,70
AB00010370	3,7 / 70 / 39	1,07	AB00010770	7,7 / 117 / 75	4,64	AB00011800	18,0 / 191 / 130	37,70
AB00010380	3,8 / 75 / 43	1,07	AB00010780	7,8 / 117 / 75	4,64	AB00011850	18,5 / 198 / 135	43,00
AB00010390	3,9 / 75 / 43	1,06	AB00010790	7,9 / 117 / 75	4,64	AB00011900	19,0 / 198 / 135	43,50
AB00010400	4,0 / 75 / 43	0,92	AB00010800	8,0 / 117 / 75	2,66	AB00011950	19,5 / 205 / 140	47,00
AB00010410	4,1 / 75 / 43	1,37	AB00010810	8,1 / 117 / 75	5,43	AB00012000	20,0 / 205 / 140	47,00
AB00010420	4,2 / 75 / 43	1,10	AB00010820	8,2 / 117 / 75	5,43			

## HSS-R DIN 338 CZARNE - ZESTAWY WIERTEŁ



Na zdjęciu zestaw AB00191085, 19 szt.

Nr artykułu	Zestaw / szt.	Ø [mm]	Cena netto [zł]
AB14000610	6	2 / 3 / 4 / 5 / 6 / 8	14,57
AB14001340	13	1,5 - 6,5 x 0,5	28,26
AB00191085	19	1 - 10 x 0,5	39,74
AB00251085	25	1 - 13 x 0,5	83,89
AB00501085	50	1 - 5,9 x 0,1	109,00
AB00140041	41	6 - 10 x 0,1	249,00
AB14015000*	170	(1 - 8 x 0,5) x 10 (8,5 - 10) x 5	288,00
AB14100000**	345	1 - 13	729,00

\* w zestawie walizkowym

\*\* w skrzynce ekspozycyjnej

**HIT!**

**WIERTŁA HSS-GS DIN 338, 135°, SZLIFOWANE**

- opakowanie z tworzywa sztucznego
- **podana cena netto [zł] za 1 sztukę wiertła**
- Ø 1,0 - 7,0 mm - 10 sztuk w opakowaniu
- Ø 7,1 - 13,0 mm - 5 sztuk w opakowaniu

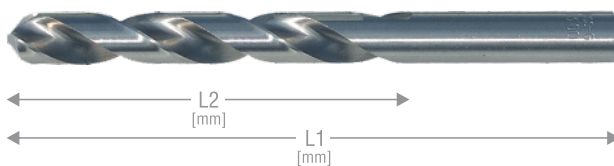

Nr artykułu	Ø / L1 / L2	Cena netto [zł]	Nr artykułu	Ø / L1 / L2	Cena netto [zł]	Nr artykułu	Ø / L1 / L2	Cena netto [zł]
AB00010101	1,0 / 34 / 12	1,85	AB00010431	4,3 / 80 / 47	4,22	AB00010761	7,6 / 117 / 75	12,04
AB00010111	1,1 / 36 / 14	1,85	AB00010441	4,4 / 80 / 47	4,22	AB00010771	7,7 / 117 / 75	12,04
AB00010121	1,2 / 38 / 16	1,85	AB00010451	4,5 / 80 / 47	3,09	AB00010781	7,8 / 117 / 75	12,04
AB00010131	1,3 / 38 / 16	1,85	AB00010461	4,6 / 80 / 47	4,27	AB00010791	7,9 / 117 / 75	12,04
AB00010141	1,4 / 40 / 18	1,85	AB00010471	4,7 / 80 / 47	4,27	AB00010801	8,0 / 117 / 75	9,36
AB00010151	1,5 / 40 / 18	1,77	AB00010481	4,8 / 86 / 52	3,30	AB00010811	8,1 / 117 / 75	12,36
AB00010161	1,6 / 43 / 20	1,85	AB00010491	4,9 / 86 / 52	4,59	AB00010821	8,2 / 117 / 75	12,36
AB00010171	1,7 / 43 / 20	1,85	AB00010501	5,0 / 86 / 52	3,30	AB00010831	8,3 / 117 / 75	12,90
AB00010181	1,8 / 46 / 22	1,85	AB00010511	5,1 / 86 / 52	4,34	AB00010841	8,4 / 117 / 75	12,90
AB00010191	1,9 / 46 / 22	1,85	AB00010521	5,2 / 86 / 52	4,34	AB00010851	8,5 / 117 / 75	10,19
AB00010201	2,0 / 49 / 24	1,77	AB00010531	5,3 / 86 / 52	5,79	AB00010861	8,6 / 125 / 81	16,04
AB00010211	2,1 / 49 / 24	1,68	AB00010541	5,4 / 93 / 57	5,79	AB00010871	8,7 / 125 / 81	16,04
AB00010221	2,2 / 53 / 27	1,68	AB00010551	5,5 / 93 / 57	4,44	AB00010881	8,8 / 125 / 81	16,12
AB00010231	2,3 / 53 / 27	1,68	AB00010561	5,6 / 93 / 57	6,13	AB00010891	8,9 / 125 / 81	16,12
AB00010241	2,4 / 57 / 30	1,68	AB00010571	5,7 / 93 / 57	4,95	AB00010901	9,0 / 125 / 81	11,78
AB00010251	2,5 / 57 / 30	1,50	AB00010581	5,8 / 93 / 57	5,79	AB00010911	9,1 / 125 / 81	16,20
AB00010261	2,6 / 57 / 30	1,85	AB00010591	5,9 / 93 / 57	5,79	AB00010921	9,2 / 125 / 81	16,20
AB00010271	2,7 / 61 / 33	1,85	AB00010601	6,0 / 93 / 57	4,93	AB00010931	9,3 / 125 / 81	15,17
AB00010281	2,8 / 61 / 33	1,85	AB00010611	6,1 / 101 / 63	6,09	AB00010941	9,4 / 125 / 81	15,17
AB00010291	2,9 / 61 / 33	1,85	AB00010621	6,2 / 101 / 63	6,09	AB00010951	9,5 / 125 / 81	13,08
AB00010301	3,0 / 61 / 33	1,82	AB00010631	6,3 / 101 / 63	7,06	AB00010961	9,6 / 133 / 87	19,20
AB00010311	3,1 / 65 / 36	2,47	AB00010641	6,4 / 101 / 63	7,06	AB00010971	9,7 / 133 / 87	19,20
AB00010321	3,2 / 65 / 36	2,12	AB00010651	6,5 / 101 / 63	5,39	AB00010981	9,8 / 133 / 87	18,91
AB00010331	3,3 / 65 / 36	2,15	AB00010661	6,6 / 101 / 63	8,71	AB00010991	9,9 / 133 / 87	18,91
AB00010341	3,4 / 70 / 39	3,28	AB00010671	6,7 / 101 / 63	8,71	AB00011001	10,0 / 133 / 87	14,96
AB00010351	3,5 / 70 / 39	2,12	AB00010681	6,8 / 109 / 69	6,30	AB00011021	10,2 / 133 / 87	16,34
AB00010361	3,6 / 70 / 39	3,44	AB00010691	6,9 / 109 / 69	9,58	AB00011051	10,5 / 133 / 87	16,34
AB00010371	3,7 / 70 / 39	3,44	AB00010701	7,0 / 109 / 69	6,30	AB00011101	11,0 / 142 / 94	18,86
AB00010381	3,8 / 75 / 43	2,91	AB00010711	7,1 / 109 / 69	10,49	AB00011151	11,5 / 142 / 94	20,53
AB00010391	3,9 / 75 / 43	3,57	AB00010721	7,2 / 109 / 69	10,49	AB00011201	12,0 / 151 / 101	23,44
AB00010401	4,0 / 75 / 43	2,38	AB00010731	7,3 / 109 / 69	10,49	AB00011251	12,5 / 151 / 101	25,44
AB00010411	4,1 / 75 / 43	3,18	AB00010741	7,4 / 109 / 69	10,49	AB00011301	13,0 / 151 / 101	27,33
AB00010421	4,2 / 75 / 43	3,00	AB00010751	7,5 / 109 / 69	7,45			

**WIERTŁA HSS-GS DIN 340 SZLIFOWANE WYDŁUŻONE**

- opakowanie z tworzywa sztucznego
- **podana cena netto [zł] za 1 sztukę wiertła**
- Ø 2,0 - 7,0 mm - 10 sztuk w opakowaniu
- Ø 7,5 - 13,0 mm - 5 sztuk w opakowaniu

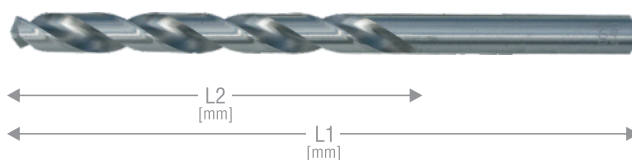

Nr artykułu	Ø / L1 / L2	Cena netto [zł]	Nr artykułu	Ø / L1 / L2	Cena netto [zł]	Nr artykułu	Ø / L1 / L2	Cena netto [zł]
AB44002000	2,0 / 85 / 56	1,95	AB44004800	4,8 / 132 / 87	5,75	AB44009000	9,0 / 175 / 115	20,58
AB44002500	2,5 / 95 / 62	2,13	AB44005000	5,0 / 132 / 87	5,75	AB44009500	9,5 / 175 / 115	22,44
AB44003000	3,0 / 100 / 66	3,34	AB44005200	5,2 / 132 / 87	7,79	AB44010000	10,0 / 184 / 121	26,24
AB44003200	3,2 / 106 / 69	3,80	AB44005500	5,5 / 139 / 91	7,32	AB44010500	10,5 / 184 / 121	28,56
AB44003300	3,3 / 112 / 73	3,80	AB44006000	6,0 / 139 / 91	8,16	AB44011000	11,0 / 195 / 128	33,19
AB44003500	3,5 / 112 / 73	3,80	AB44006200	6,2 / 148 / 97	9,79	AB44011500	11,5 / 195 / 128	36,16
AB44003800	3,8 / 119 / 78	3,99	AB44006500	6,5 / 148 / 97	9,69	AB44012000	12,0 / 205 / 134	41,35
AB44004000	4,0 / 119 / 78	3,99	AB44007000	7,0 / 156 / 102	11,39	AB44012500	12,5 / 205 / 134	44,97
AB44004100	4,1 / 119 / 78	5,28	AB44007500	7,5 / 156 / 102	12,42	AB44013000	13,0 / 205 / 134	48,40
AB44004200	4,2 / 119 / 78	4,91	AB44008000	8,0 / 165 / 109	16,23			
AB44004500	4,5 / 126 / 82	4,91	AB44008500	8,5 / 165 / 109	17,34			

## HSS-GS DIN 338 SZLIFOWANE - ZESTAWY WIERTEL



Nr artykułu	Zestaw / szt.	Ø [mm]	Cena netto [zł]
AB14100610	6	2 - 3 - 4 - 5 - 6 - 8	27,17
AB00141119	19	1 - 10 x 0,5	89,00
AB00141125	25	1 - 13 x 0,5	179,00
AB14017001*	170	(1 - 8 x 0,5) x 10 (8,5 - 10) x 5	499,00 <b>HIT!</b>
AB14100001**	255	1 - 13	1780,21

\* w zestawie walizkowym

\*\* w skrzynce ekspozycyjnej

Na zdjęciu zestaw AB00141119, 19 szt.

## WIERTŁA HSS-GS TIN DIN 338, 135°, TYTANOWANE

- opakowanie z tworzywa sztucznego
- **podana cena netto [zł] za 1 sztukę wiertła**
- Ø 1,0 - 7,0 mm - 10 sztuk w opakowaniu
- Ø 7,5 - 13,0 mm - 5 sztuk w opakowaniu

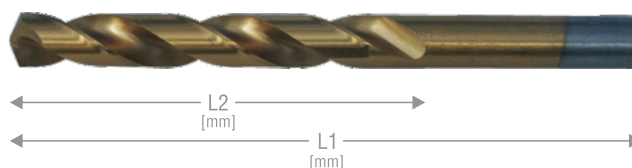

Nr artykułu	Ø / L1 / L2	Cena netto [zł]	Nr artykułu	Ø / L1 / L2	Cena netto [zł]	Nr artykułu	Ø / L1 / L2	Cena netto [zł]
AB00010103	1,0 / 34 / 12	1,89	AB00010453	4,5 / 80 / 47	3,35	AB00010903	9,0 / 125 / 81	11,95
AB00010153	1,5 / 40 / 18	1,92	AB00010503	5,0 / 86 / 52	3,95	AB00010953	9,5 / 125 / 81	12,15
AB00010203	2,0 / 49 / 24	1,98	AB00010553	5,5 / 93 / 57	4,45	AB00011003	10,0 / 133 / 87	15,45
AB00010253	2,5 / 57 / 30	1,98	AB00010603	6,0 / 93 / 57	4,95	AB00011053	10,5 / 133 / 87	16,53
AB00010303	3,0 / 61 / 33	2,03	AB00010653	6,5 / 101 / 63	5,45	AB00011103	11,0 / 142 / 94	19,50
AB00010323	3,2 / 65 / 36	2,18	AB00010703	7,0 / 109 / 69	6,45	AB00011153	11,5 / 142 / 94	20,95
AB00010353	3,5 / 70 / 39	2,18	AB00010753	7,5 / 109 / 69	7,95	AB00011203	12,0 / 151 / 101	23,95
AB00010403	4,0 / 75 / 43	2,43	AB00010803	8,0 / 117 / 75	9,95	AB00011253	12,5 / 151 / 101	25,95
AB00010423	4,2 / 75 / 43	3,29	AB00010853	8,5 / 117 / 75	10,05	AB00011303	13,0 / 151 / 101	27,95

- pokrowiec z tworzywa sztucznego (etui)
- **podana cena netto [zł] za opakowanie**
- Ø 1,0 - 4,0 mm - 2 sztuki w opakowaniu
- Ø 4,2 - 13,0 mm - 1 sztuka w opakowaniu

Nr artykułu	Ø / L1 / L2	Cena netto [zł]	Nr artykułu	Ø / L1 / L2	Cena netto [zł]	Nr artykułu	Ø / L1 / L2	Cena netto [zł]
AB42001000	1,0 / 34 / 12	3,79	AB42004500	4,5 / 80 / 47	3,39	AB42009000	9,0 / 125 / 81	12,00
AB42001500	1,5 / 40 / 18	3,89	AB42005000	5,0 / 86 / 52	3,99	AB42009500	9,5 / 125 / 81	12,20
AB42002000	2,0 / 49 / 24	3,99	AB42005500	5,5 / 93 / 57	4,50	AB42010000	10,0 / 133 / 87	15,50
AB42002500	2,5 / 57 / 30	3,99	AB42006000	6,0 / 93 / 57	4,99	AB42010500	10,5 / 133 / 87	16,59
AB42003000	3,0 / 61 / 33	4,10	AB42006500	6,5 / 101 / 63	5,50	AB42011000	11,0 / 142 / 94	19,59
AB42003200	3,2 / 65 / 36	4,39	AB42007000	7,0 / 109 / 69	6,50	AB42011500	11,5 / 142 / 94	20,99
AB42003500	3,5 / 70 / 39	4,39	AB42007500	7,5 / 109 / 69	7,99	AB42012000	12,0 / 151 / 101	23,99
AB42004000	4,0 / 75 / 43	4,89	AB42008000	8,0 / 117 / 75	9,99	AB42012500	12,5 / 151 / 101	25,99
AB42004200	4,2 / 75 / 43	3,30	AB42008500	8,5 / 117 / 75	10,10	AB42013000	13,0 / 151 / 101	27,99

## HSS-TIN DIN 338 TYTANOWANE - ZESTAWY WIERTEL



Nr artykułu	Zestaw / szt.	Ø [mm]	Cena netto [zł]
AB14200610	6	2 - 3 - 4 - 5 - 6 - 8	31,99
AB00142019	19	1 - 10 x 0,5	99,00 <b>HIT!</b>

Na zdjęciu zestaw AB00142019, 19 szt.

**WIERTŁA HSS-Co DIN 338, 135°, KOBALTOWE (5%)**

- opakowanie z tworzywa sztucznego
- **podana cena netto [zł] za 1 sztukę wiertła**
- Ø 1,0 - 7,0 mm - 10 sztuk w opakowaniu
- Ø 7,1 - 13,0 mm - 5 sztuk w opakowaniu
- Ø 13,5 i większe - 1 sztuka w opakowaniu

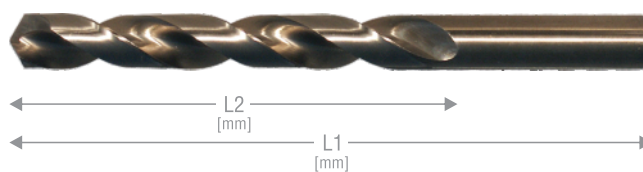

Nr artykułu	Ø / L1 / L2	Cena netto [zł]	Nr artykułu	Ø / L1 / L2	Cena netto [zł]	Nr artykułu	Ø / L1 / L2	Cena netto [zł]
AB00010102	1,0 / 34 / 12	5,66	AB00010462	4,6 / 80 / 47	8,02	AB00010822	8,2 / 117 / 75	22,44
AB00010112	1,1 / 36 / 14	5,75	AB00010472	4,7 / 80 / 47	8,02	AB00010832	8,3 / 117 / 75	22,44
AB00010122	1,2 / 38 / 16	5,75	AB00010482	4,8 / 86 / 52	8,02	AB00010842	8,4 / 117 / 75	22,44
AB00010132	1,3 / 38 / 16	5,75	AB00010492	4,9 / 86 / 52	8,07	AB00010852	8,5 / 117 / 75	19,38
AB00010142	1,4 / 40 / 18	5,75	AB00010502	5,0 / 86 / 52	7,00	AB00010862	8,6 / 125 / 81	24,85
AB00010152	1,5 / 40 / 18	5,66	AB00010512	5,1 / 86 / 52	9,64	AB00010872	8,7 / 125 / 81	24,85
AB00010162	1,6 / 43 / 20	5,75	AB00010522	5,2 / 86 / 52	9,64	AB00010882	8,8 / 125 / 81	24,85
AB00010172	1,7 / 43 / 20	5,75	AB00010532	5,3 / 86 / 52	9,64	AB00010892	8,9 / 125 / 81	24,85
AB00010182	1,8 / 46 / 22	5,75	AB00010542	5,4 / 93 / 57	9,64	AB00010902	9,0 / 125 / 81	21,14
AB00010192	1,9 / 46 / 22	5,75	AB00010552	5,5 / 93 / 57	9,09	AB00010912	9,1 / 125 / 81	27,91
AB00010202	2,0 / 49 / 24	4,54	AB00010562	5,6 / 93 / 57	10,85	AB00010922	9,2 / 125 / 81	27,91
AB00010212	2,1 / 49 / 24	5,79	AB00010572	5,7 / 93 / 57	10,85	AB00010932	9,3 / 125 / 81	27,91
AB00010222	2,2 / 53 / 27	5,79	AB00010582	5,8 / 93 / 57	10,85	AB00010942	9,4 / 125 / 81	27,91
AB00010232	2,3 / 53 / 27	5,79	AB00010592	5,9 / 93 / 57	10,85	AB00010952	9,5 / 125 / 81	23,09
AB00010242	2,4 / 57 / 30	5,79	AB00010602	6,0 / 93 / 57	9,27	AB00010962	9,6 / 133 / 87	33,90
AB00010252	2,5 / 57 / 30	4,40	AB00010612	6,1 / 101 / 63	12,89	AB00010972	9,7 / 133 / 87	33,90
AB00010262	2,6 / 57 / 30	5,70	AB00010622	6,2 / 101 / 63	12,89	AB00010982	9,8 / 133 / 87	33,90
AB00010272	2,7 / 61 / 33	5,70	AB00010632	6,3 / 101 / 63	12,89	AB00010992	9,9 / 133 / 87	33,90
AB00010282	2,8 / 61 / 33	5,70	AB00010642	6,4 / 101 / 63	12,89	AB00011002	10,0 / 133 / 87	28,19
AB00010292	2,9 / 61 / 33	5,70	AB00010652	6,5 / 101 / 63	11,59	AB00011022	10,2 / 133 / 87	40,18
AB00010302	3,0 / 61 / 33	4,45	AB00010662	6,6 / 101 / 63	15,21	AB00011052	10,5 / 133 / 87	36,25
AB00010312	3,1 / 65 / 36	5,42	AB00010672	6,7 / 101 / 63	15,21	AB00011102	11,0 / 142 / 94	36,25
AB00010322	3,2 / 65 / 36	5,42	AB00010682	6,8 / 109 / 69	13,44	AB00011152	11,5 / 142 / 94	43,00
AB00010332	3,3 / 65 / 36	5,42	AB00010692	6,9 / 109 / 69	15,21	AB00011202	12,0 / 151 / 101	45,00
AB00010342	3,4 / 70 / 39	5,75	AB00010702	7,0 / 109 / 69	13,17	AB00011252	12,5 / 151 / 101	55,45
AB00010352	3,5 / 70 / 39	5,75	AB00010712	7,1 / 109 / 69	16,69	AB00011302	13,0 / 151 / 101	56,84
AB00010362	3,6 / 70 / 39	6,77	AB00010722	7,2 / 109 / 69	16,69	AB00011352	13,5 / 160 / 108	68,89
AB00010372	3,7 / 70 / 39	6,77	AB00010732	7,3 / 109 / 69	16,69	AB00011402	14,0 / 160 / 108	68,89
AB00010382	3,8 / 75 / 43	6,77	AB00010742	7,4 / 109 / 69	16,69	AB00011452	14,5 / 169 / 114	92,00
AB00010392	3,9 / 75 / 43	6,77	AB00010752	7,5 / 109 / 69	15,30	AB00011502	15,0 / 169 / 114	95,00
AB00010402	4,0 / 75 / 43	6,07	AB00010762	7,6 / 117 / 75	20,99	AB00011552	15,5 / 178 / 120	105,00
AB00010412	4,1 / 75 / 43	7,26	AB00010772	7,7 / 117 / 75	20,99	AB00011602	16,0 / 178 / 120	117,75
AB00010422	4,2 / 75 / 43	6,86	AB00010782	7,8 / 117 / 75	20,99	AB00011702	17,0 / 184 / 125	133,05
AB00010432	4,3 / 80 / 47	7,26	AB00010792	7,9 / 117 / 75	20,99	AB00011802	18,0 / 191 / 130	158,55
AB00010442	4,4 / 80 / 47	7,26	AB00010802	8,0 / 117 / 75	17,80	AB00011902	19,0 / 198 / 135	174,31
AB00010452	4,5 / 80 / 47	7,09	AB00010812	8,1 / 117 / 75	22,44	AB00012002	20,0 / 205 / 140	205,56

- pokrowiec z tworzywa sztucznego (etui)
- **podana cena netto [zł] za opakowanie**
- Ø 1,0 - 4,0 mm - 2 sztuki w opakowaniu
- Ø 4,2 - 13,0 mm - 1 sztuka w opakowaniu

Nr artykułu	Ø / L1 / L2	Cena netto [zł]	Nr artykułu	Ø / L1 / L2	Cena netto [zł]	Nr artykułu	Ø / L1 / L2	Cena netto [zł]
AB41901000	1,0 / 34 / 12	12,99	AB41904200	4,2 / 75 / 43	7,99	AB41908000	8,0 / 117 / 75	19,04
AB41901500	1,5 / 40 / 18	12,99	AB41904500	4,5 / 80 / 47	7,99	AB41908500	8,5 / 117 / 75	20,73
AB41902000	2,0 / 49 / 24	10,20	AB41905000	5,0 / 86 / 52	7,99	AB41909000	9,0 / 125 / 81	22,62
AB41902500	2,5 / 57 / 30	10,50	AB41905500	5,5 / 93 / 57	9,99	AB41910000	10,0 / 133 / 87	31,00
AB41903000	3,0 / 61 / 33	9,99	AB41906000	6,0 / 93 / 57	10,49	AB41911000	11,0 / 142 / 94	38,78
AB41903200	3,2 / 65 / 36	12,30	AB41906500	6,5 / 101 / 63	12,40	AB41912000	12,0 / 151 / 101	50,00
AB41903500	3,5 / 70 / 39	12,30	AB41907000	7,0 / 109 / 69	14,40	AB41913000	13,0 / 151 / 101	65,00
AB41904000	4,0 / 75 / 43	13,49	AB41907500	7,5 / 109 / 69	16,37			

## HSS-Co DIN 338 KOBALTOWE - ZESTAWY WIERTEL



Nr artykułu	Zestaw / szt.	Ø [mm]	Cena netto [zł]
AB14190610	6	2 - 3 - 4 - 5 - 6 - 8	49,00
AB00141919	19	1 - 10 x 0,5	211,40
AB00141925	25	1 - 13 x 0,5	469,00
AB14100002*	185	1 - 13	2699,00

\* w skrzynce ekspozycyjnej

Na zdjęciu zestaw AB00141919, 19 szt.

## WIERTŁA HSS-R DIN 338 CZARNE PRZETOCZONE

- opakowanie z tworzywa sztucznego
- **podana cena netto [zł] za 1 sztukę wiertła**
- 1 sztuka w opakowaniu



Nr artykułu	Ø / L1 / L2	Cena netto [zł]	Nr artykułu	Ø / L1 / L2	Cena netto [zł]	Nr artykułu	Ø / L1 / L2	Cena netto [zł]
AB00011104	11,0 / 142 / 94	12,05	AB00011501	15,0 / 169 / 114	23,99	AB00011801	18,0 / 191 / 130	57,00
AB00011204	12,0 / 151 / 101	13,91	AB00011551	15,5 / 178 / 120	28,50	AB00011851	18,5 / 198 / 135	65,00
AB00011304	13,0 / 151 / 101	15,79	AB00011601	16,0 / 178 / 120	29,00	AB00011901	19,0 / 198 / 135	65,00
AB00011354	13,5 / 160 / 108	19,44	AB00011651	16,5 / 184 / 125	50,00	AB00011951	19,5 / 205 / 140	73,00
AB00011401	14,0 / 160 / 108	19,79	AB00011701	17,0 / 184 / 125	50,00	AB00012001	20,0 / 205 / 140	73,00
AB00011451	14,5 / 169 / 114	23,33	AB00011751	17,5 / 191 / 130	57,00			

## WIERTŁA HSS DIN 345 CZARNE NA STOŻEK MORSE'A (NWKC)

- do użytku w przemyśle; wysoka precyzja i żywotność
- **podana cena netto [zł] za 1 sztukę wiertła**
- 1 sztuka w opakowaniu

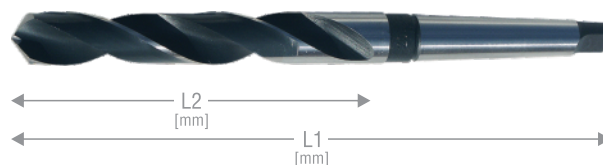

Nr artykułu	Ø / L1 / L2	Cena netto [zł]	Nr artykułu	Ø / L1 / L2	Cena netto [zł]	Nr artykułu	Ø / L1 / L2	Cena netto [zł]
	1		AB44518500	18,5 / 233 / 135	43,25	AB44529500	29,5 / 296 / 175	135,14
AB44506000	6,0 / 138 / 57	18,55	AB44519000	19,0 / 233 / 135	46,04	AB44530000	30,0 / 296 / 175	158,10
AB44508000	8,0 / 156 / 75	25,99	AB44519500	19,5 / 238 / 140	46,04	AB44531000	31,0 / 301 / 180	178,01
AB44508500	8,5 / 156 / 75	25,99	AB44520000	20,0 / 238 / 140	54,71		4	
AB44509000	9,0 / 162 / 81	26,99	AB44520500	20,5 / 243 / 145	54,71	AB44532000	32,0 / 334 / 185	182,21
AB44509500	9,5 / 162 / 81	26,99	AB44521000	21,0 / 243 / 145	63,10	AB44533000	33,0 / 334 / 185	188,64
AB44510000	10,0 / 168 / 87	25,99	AB44521500	21,5 / 248 / 150	63,10	AB44534000	34,0 / 339 / 190	195,91
AB44510500	10,5 / 168 / 87	25,99	AB44522000	22,0 / 248 / 150	65,99	AB44535000	35,0 / 339 / 190	215,39
AB44511000	11,0 / 175 / 94	25,99	AB44522500	22,5 / 253 / 155	65,99	AB44536000	36,0 / 344 / 195	234,68
AB44511500	11,5 / 175 / 94	25,99	AB44523000	23,0 / 253 / 155	74,75	AB44537000	37,0 / 344 / 195	287,99
AB44512000	12,0 / 182 / 101	25,99		3		AB44538000	38,0 / 349 / 200	287,99
AB44512500	12,5 / 182 / 101	25,99	AB44523500	23,5 / 276 / 155	86,21	AB44539000	39,0 / 349 / 200	303,37
AB44513000	13,0 / 182 / 101	27,96	AB44524000	24,0 / 281 / 160	86,21	AB44540000	40,0 / 349 / 200	303,37
AB44513500	13,5 / 189 / 108	27,96	AB44524500	24,5 / 281 / 160	86,21	AB44541000	41,0 / 354 / 205	303,37
	2		AB44525000	25,0 / 281 / 160	89,01	AB44542000	42,0 / 354 / 205	331,05
AB44514000	14,0 / 189 / 108	31,78	AB44525500	25,5 / 286 / 165	89,01	AB44543000	43,0 / 359 / 210	331,05
AB44514500	14,5 / 212 / 114	31,78	AB44526000	26,0 / 286 / 165	109,14	AB44544000	44,0 / 359 / 210	369,08
AB44515000	15,0 / 212 / 114	31,78	AB44526500	26,5 / 286 / 165	109,14	AB44545000	45,0 / 359 / 210	422,20
AB44515500	15,5 / 218 / 120	31,87	AB44527000	27,0 / 291 / 170	112,12	AB44546000	46,0 / 364 / 215	422,20
AB44516000	16,0 / 218 / 120	34,67	AB44527500	27,5 / 291 / 170	112,12	AB44547000	47,0 / 364 / 215	475,32
AB44516500	16,5 / 223 / 125	37,47	AB44528000	28,0 / 291 / 170	117,81	AB44548000	48,0 / 369 / 220	475,32
AB44517000	17,0 / 223 / 125	40,36	AB44528500	28,5 / 296 / 175	117,81	AB44549000	49,0 / 369 / 220	475,32
AB44517500	17,5 / 228 / 130	40,36	AB44529000	29,0 / 296 / 175	135,14	AB44550000	50,0 / 369 / 220	523,79
AB44518000	18,0 / 228 / 130	43,25						

## wierła do metalu

### HSS-G Z TRZPIENIEM E 6,3



Nr artykułu	Ø / L1 / L2	Cena netto [zł]
AB43003000	3 / 47/16	11,53
AB43004000	4 / 53/20	11,53
AB43005000	5 / 59/26	11,53
AB43006000	6 / 59/26	11,53
AB43007000	7 / 59/30	12,53
AB43008000	8 / 60/32	12,53

### HSS E 6,3 Z GWINTOWNIKIEM



Nr artykułu	Gwint / L1 / otwór	Cena netto [zł]
AB45600003	M3 / 35 / 2,5	22,19
AB45600004	M4 / 39 / 3,3	22,19
AB45600005	M5 / 41 / 4,2	22,19
AB45600006	M6 / 44 / 5,0	22,19
AB45600008	M8 / 51 / 6,8	22,19
AB45600010	M10 / 59 / 8,5	22,19

### HSS-Co (5%) / HSS-G STOPNIOWE METRYCZNE



Nr artykułu	Materiał	Ø [mm]	Cena netto [zł]
AB91150420	HSS-Co	4,0 - 20,0	159,00
AB91150430	HSS-Co	4,0 - 30,0	269,00
AB91140412	HSS-G	4,0 - 12,0	87,66
AB91140420	HSS-G	4,0 - 20,0	115,06
AB91140630	HSS-G	4,0 - 30,0	201,95
AB91140638	HSS-G	6,0 - 38,0	266,47

### HSS-G PRECYZYJNE ŁUSZCZENIOWE



Nr artykułu	Ø [mm]	Cena netto [zł]
AB91000620	5,0 - 20,0	73,23
AB91000630	5,0 - 31,0	161,73
AB91001630	16,0 - 30,5	134,02
AB91002640	24,0 - 40,0	224,95

### HSS-G DIN 335 C 90° POGŁĘBIACZ STOŻKOWY



Nr artykułu	Ø [mm]	Cena netto [zł]
AB91030063	1,5 - 6,3	43,39
AB91030083	2,0 - 8,3	43,39
AB91030104	2,5 - 10,4	45,90
AB91030124	2,8 - 12,4	51,79
AB91030165	3,2 - 16,5	58,56
AB91030205	3,5 - 20,5	73,53
AB91030250	3,8 - 25,0	95,58

### HSS-TIN FREZUJĄCE TYTANOWANE



Nr artykułu	Ø [mm]	Cena netto [zł]
AB48706000	6,0	25,03

### RYSIK STALOWY



Nr artykułu	Długość [mm]	Cena netto [zł]
AB59100000	150	9,48

## wierła do szkła i glazury

### WALCOWE DO SZKŁA I CERAMIKI



Nr artykułu	Ø / L1	Cena netto [zł]
AB51303000	3 / 65	13,16
AB51304000	4 / 65	12,90
AB51305000	5 / 65	12,90
AB51306000	6 / 65	14,17
AB51308000	8 / 80	18,47
AB51310000	10 / 80	25,43

### DIAMENTOWE DO GLAZURY I MARMURU



Nr artykułu	Ø [mm]	Cena netto [zł]
AB51504000	4	20,99
AB51505000	5	23,66
AB51506000	6	26,76
AB51508000	8	32,48
AB51510000	10	36,63
AB51512000	12	40,18
AB51516000	16	51,34
AB51525000	25	79,50



## WIERTŁA SDS-PLUS

- opakowanie z tworzywa sztucznego
- **podana cena netto [zł] za 1 sztukę wiertła**
- 1 sztuka w opakowaniu

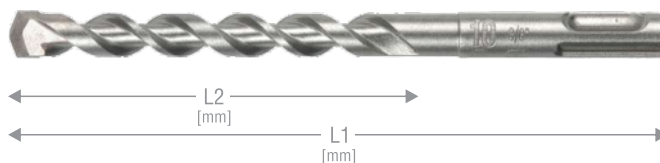

Nr artykułu	Ø / L1 / L2	Cena netto [zł]	Nr artykułu	Ø / L1 / L2	Cena netto [zł]	Nr artykułu	Ø / L1 / L2	Cena netto [zł]
AB00002351	3 / 110 / 50	11,13	AB00002393	10 / 310 / 250	21,90	AB00002333	16 / 450 / 400	44,98
AB00002352	4 / 110 / 50	9,27	AB00002317	10 / 450 / 400	33,50	AB00002334	16 / 600 / 550	63,39
AB00002396	4 / 160 / 100	13,54	AB00002363	10 / 600 / 550	46,17	AB62816003	16 / 800 / 750	111,67
AB00002301	5 / 110 / 50	7,05	AB62910003	10 / 1000 / 950	102,55	AB62916003	16 / 1000 / 950	163,91
AB00002395	5 / 160 / 100	8,07	AB00002320	12 / 160 / 100	13,35	AB62914004	16 / 1400 / 1350	231,19
AB00002302	5,5 / 110 / 50	7,97	AB00002359	12 / 210 / 150	16,30	AB00002336	18 / 210 / 150	32,60
AB00002303	5,5 / 160 / 100	9,55	AB00002321	12 / 260 / 200	20,21	AB00002337	18 / 260 / 200	40,03
AB00002304	6 / 110 / 50	7,39	AB60712000	12 / 310 / 260	24,11	AB00002394	18 / 310 / 250	43,99
AB00002305	6 / 160 / 100	8,19	AB00002322	12 / 450 / 400	38,11	AB00002354	18 / 450 / 400	53,12
AB00002364	6 / 210 / 150	12,80	AB00002323	12 / 600 / 550	45,62	AB62618000	18 / 600 / 550	69,90
AB00002307	6 / 260 / 200	19,66	AB62912003	12 / 1000 / 950	135,18	AB62918003	18 / 1000 / 950	141,91
AB60806000	6 / 350 / 300	27,17	AB62912004	12 / 1400 / 1350	249,29	AB00002339	20 / 210 / 150	42,07
AB00002365	6,5 / 210 / 150	14,59	AB00002326	14 / 160 / 100	18,54	AB00002355	20 / 310 / 250	50,89
AB00002367	6,5 / 260 / 200	25,50	AB00002360	14 / 210 / 150	22,10	AB00002340	20 / 450 / 400	65,24
AB00002308	7 / 110 / 50	8,53	AB00002327	14 / 260 / 200	25,20	AB62620003	20 / 600 / 550	79,58
AB00002309	7 / 160 / 110	9,18	AB00002361	14 / 310 / 250	29,02	AB62920000	20 / 1000 / 950	153,54
AB00002310	8 / 110 / 50	8,25	AB00002379	14 / 450 / 400	37,00	AB00002341	22 / 260 / 200	63,01
AB00002311	8 / 160 / 100	8,90	AB00002328	14 / 600 / 550	54,61	AB00002342	22 / 450 / 400	82,49
AB00002312	8 / 210 / 150	11,99	AB62914003	14 / 1000 / 950	138,34	AB62822003	22 / 800 / 750	146,18
AB00002356	8 / 260 / 200	15,70	AB00002329	15 / 160 / 100	22,33	AB62922003	22 / 1000 / 950	170,99
AB00002313	8 / 310 / 260	28,74	AB00002366	15 / 210 / 150	25,41	AB00002345	24 / 260 / 200	69,79
AB00002398	8 / 450 / 400	32,08	AB00002330	15 / 260 / 200	29,11	AB00002346	24 / 450 / 400	99,94
AB62608000	8 / 600 / 550	57,21	AB00002331	15 / 450 / 400	49,33	AB00002347	25 / 260 / 200	71,25
AB00002314	10 / 110 / 50	9,49	AB00002372	16 / 160 / 100	25,01	AB00002348	25 / 450 / 400	105,75
AB00002315	10 / 160 / 100	10,55	AB00002332	16 / 210 / 150	26,75	AB62925003	25 / 1000 / 950	188,54
AB00002357	10 / 210 / 150	13,07	AB00002335	16 / 260 / 200	29,90	AB00002349	26 / 260 / 200	91,31
AB00002316	10 / 260 / 200	16,49	AB00002353	16 / 310 / 250	33,67	AB00002350	26 / 450 / 400	116,81

## SDS-PLUS - ZESTAWY WIERTEŁ



Na zdjęciu zestaw AB16990463, 4 szt.

Nr artykułu	Ø / L1	Cena netto [zł]
AB16990463	5 / 110, 6 / 110, 8 / 160, 10 / 160	41,90

Nr artykułu	Zestaw / szt.	Ø / L1 / L2	Cena netto [zł]
AB00000002	10	6 / 110 / 50	70,70
AB00000004	10	6 / 160 / 100	78,50
AB00000003	10	8 / 110 / 50	79,77
AB00000005	10	8 / 160 / 100	86,90
AB00000007	10	8 / 210 / 150	116,70
AB00000006	10	10 / 160 / 100	101,00
AB00000008	10	10 / 210 / 150	125,61
AB00000009	8	12 / 210 / 150	125,61

## OTWORNICE SDS-PLUS



Nr artykułu	Ø [mm]	Cena netto [zł]
AB72206600	66	116,88
AB72208200	82	126,27

Nr artykułu	Opis	Cena netto [zł]
AB72200000	uchwyt do otwornicy SDS-Plus, dł. 110 mm	23,60
AB72100001	uchwyt 6-kąt do otwornicy, dł. 100 mm	23,60
AB72808000	wiertło prowadzące Ø 8 mm, dł. 120 mm	5,51

**DŁUTA SDS-PLUS**

- podana cena netto [zł] za 1 sztukę dłuta
- 5 sztuk w opakowaniu (AB63500000 - 1 szt.)



Nr artykułu	Typ	Wymiary [mm]	Cena netto [zł]
AB63100000	plaskie	250 x 20	18,06
AB63000000	szpic	250	18,06
AB63300000	bruzdownica	250 x 22	36,12
AB63200000	szerokie	250 x 40	29,60
AB63210000	przecinak łopatkowy	250 x 40	42,65
AB63600000	ekstra szerokie do kafli	165 x 75	52,18
AB63500000	zębate	200 x 32	277,62

**WIERTŁA WALCOWE DO CEGŁY I ZAPRAW**

- opakowanie z tworzywa sztucznego
- podana cena netto [zł] za 1 sztukę wiertła
- 1 sztuka w opakowaniu

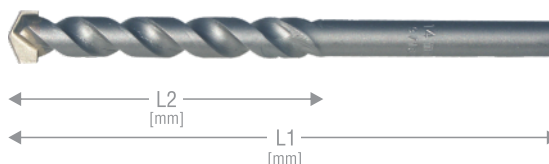

Nr artykułu	Ø / L1 / L2	Cena netto [zł]	Nr artykułu	Ø / L1 / L2	Cena netto [zł]	Nr artykułu	Ø / L1 / L2	Cena netto [zł]
AB50003000	3 / 60 / 30	2,15	AB50006000	6 / 100 / 60	2,54	AB50012000	12 / 150 / 85	5,74
AB50004000	4 / 75 / 40	2,15	AB50008000	8 / 120 / 80	3,20	AB50014000	14 / 150 / 95	7,73
AB50005000	5 / 85 / 50	2,32	AB50010000	10 / 120 / 80	3,97	AB50016000	16 / 150 / 95	8,72

**WIERTŁA WALCOWE DO CEGŁY I ZAPRAW - ZESTAWY WIERTEŁ**



Nr artykułu	Ø / L1	Cena netto [zł]
AB15000540	4 / 75, 5 / 85, 6 / 100, 8 / 120, 10 / 120	19,04

**WIERTŁA WALCOWE DO BETONU STANDARD**

- opakowanie z tworzywa sztucznego
- podana cena netto [zł] za 1 sztukę wiertła
- 1 sztuka w opakowaniu

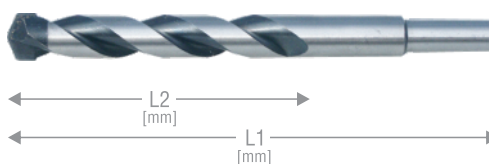

Nr artykułu	Ø / L1 / L2	Cena netto [zł]	Nr artykułu	Ø / L1 / L2	Cena netto [zł]	Nr artykułu	Ø / L1 / L2	Cena netto [zł]
AB50103000	3 / 60 / 30	2,96	AB50106000	6 / 100 / 60	3,16	AB50112000	12 / 150 / 85	7,31
AB50104000	4 / 75 / 40	2,96	AB50108000	8 / 120 / 80	3,75	AB50114000	14 / 150 / 95	8,50
AB50105000	5 / 85 / 50	2,96	AB50110000	10 / 120 / 80	5,04			

## WIERTŁA WALCOWE DO BETONU DIAMANT EVOLUTION 3

- opakowanie z tworzywa sztucznego
- **podana cena netto [zł] za 1 sztukę wiertła**
- 1 sztuka w opakowaniu

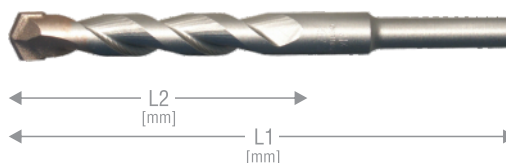

Nr artykułu	Ø / L1 / L2	Cena netto [zł]	Nr artykułu	Ø / L1 / L2	Cena netto [zł]	Nr artykułu	Ø / L1 / L2	Cena netto [zł]
AB50803000	3 / 60 / 30	3,80	AB50808000	8 / 120 / 80	6,85	AB51406000	6 / 200 / 130	12,56
AB50804000	4 / 75 / 40	3,90	AB50810000	10 / 120 / 80	9,51	AB51408000	8 / 200 / 130	12,00
AB50805000	5 / 85 / 50	3,99	AB50812000	12 / 150 / 85	12,65	AB51410000	10 / 200 / 130	14,59
AB50806000	6 / 100 / 60	4,66	AB50814000	14 / 150 / 95	18,16	AB51412000	12 / 200 / 130	16,16
AB50807000	7 / 100 / 60	6,37	AB50816000	16 / 150 / 95	22,44	AB51414000	14 / 200 / 130	22,62

## DIAMANT EVO3 - ZESTAW WIERTEŁ DO BETONU



Nr artykułu	Ø / L1	Cena netto [zł]
AB15080540	4 / 75, 5 / 85, 6 / 100, 8 / 120, 10 / 120	32,16

## WALCOWE DO BETONU DIAMANT 3D

- opakowanie z tworzywa sztucznego
- **podana cena netto [zł] za 1 sztukę wiertła**
- 1 sztuka w opakowaniu

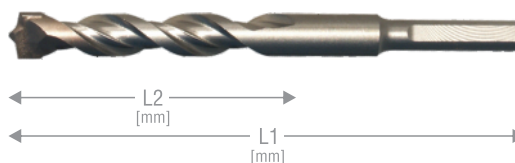

Nr artykułu	Ø / L1 / L2	Cena netto [zł]	Nr artykułu	Ø / L1 / L2	Cena netto [zł]	Nr artykułu	Ø / L1 / L2	Cena netto [zł]
AB51004000	4 / 103 / 40	7,37	AB51007000	7 / 123 / 60	9,89	AB51012000	12 / 153 / 80	20,21
AB51005000	5 / 113 / 50	5,91	AB51008000	8 / 134 / 80	9,89	AB51014000	14 / 160 / 95	30,69
AB51006000	6 / 123 / 60	6,49	AB51010000	10 / 134 / 80	12,89			

## WALCOWE DŁUGIE DO BETONU I CEGŁY



- opakowanie z tworzywa sztucznego
- **podana cena netto [zł] za 1 sztukę wiertła**
- 1 sztuka w opakowaniu

Nr artykułu	Ø / L1 / L2	Cena netto [zł]	Nr artykułu	Ø / L1 / L2	Cena netto [zł]	Nr artykułu	Ø / L1 / L2	Cena netto [zł]
AB54008000	8 / 400 / 300	12,99	AB54014000	14 / 400 / 300	20,99	AB54018000	18 / 400 / 300	30,99
AB54010000	10 / 400 / 300	14,99	AB54016000	16 / 400 / 300	26,99	AB54020000	20 / 400 / 300	39,99
AB54012000	12 / 400 / 300	15,76						

## ADAPTER SDS-MAX Z UCHWYTEM NA SDS-PLUS



Nr artykułu	Długość [mm]	Cena netto [zł]
AB69663630	200	114,85

**WIERTŁA SDS-MAX Y-CUTTER**

- głowica „Y” od Ø 16 mm
- opakowanie z tworzywa sztucznego
- podana cena netto [zł] za 1 sztukę wiertła
- 1 sztuka w opakowaniu

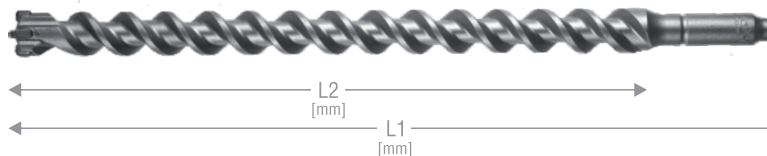

Nr artykułu	Ø / L1 / L2	Cena netto [zł]	Nr artykułu	Ø / L1 / L2	Cena netto [zł]	Nr artykułu	Ø / L1 / L2	Cena netto [zł]
AB67612003	12 / 340 / 200	84,90	AB67522003	22 / 320 / 200	146,00	AB68230000	30 / 720 / 600	292,00
AB67912003	12 / 540 / 400	95,90	AB67822003	22 / 520 / 400	159,00	AB67732003	32 / 320 / 200	199,00
AB68212000	12 / 690 / 550	112,00	AB68222000	22 / 720 / 600	235,00	AB68032003	32 / 520 / 400	239,00
AB67614000	14 / 340 / 200	88,00	AB68322003	22 / 920 / 800	255,00	AB68232000	32 / 720 / 600	319,00
AB67914003	14 / 540 / 400	107,00	AB68495221	22 / 1320 / 1200	430,00	AB68332003	32 / 920 / 800	420,00
AB67615000	15 / 340 / 200	92,48	AB67524003	24 / 320 / 200	156,00	AB68495321	32 / 1320 / 1200	625,00
AB67915003	15 / 540 / 400	111,14	AB67824003	24 / 520 / 400	177,00	AB67763503	35 / 320 / 200	225,00
AB67616000	16 / 340 / 200	116,00	AB67525003	25 / 320 / 200	163,00	AB68035003	35 / 520 / 400	259,00
AB67916003	16 / 540 / 400	138,00	AB67825003	25 / 520 / 400	199,00	AB68135003	35 / 670 / 550	285,00
AB68216005	16 / 740 / 600	199,00	AB68225000	25 / 720 / 600	255,00	AB67738003	38 / 320 / 200	275,00
AB68320000	16 / 920 / 800	235,00	AB68325003	25 / 920 / 800	279,00	AB68038003	38 / 520 / 400	279,00
AB68495161	16 / 1340 / 1200	369,00	AB68495251	25 / 1320 / 1200	499,00	AB68238000	38 / 720 / 600	450,00
AB67618000	18 / 340 / 200	124,00	AB67726003	26 / 320 / 200	210,00	AB67740003	40 / 320 / 200	319,00
AB67918003	18 / 540 / 400	150,00	AB67826003	26 / 520 / 400	235,00	AB68040003	40 / 520 / 400	319,00
AB68218000	18 / 740 / 600	235,00	AB67728003	28 / 320 / 200	175,00	AB68240000	40 / 720 / 600	499,00
AB68320001	18 / 940 / 800	270,00	AB68028003	28 / 520 / 400	222,00	AB68340003	40 / 920 / 800	499,00
AB67520003	20 / 320 / 200	133,00	AB68128003	28 / 720 / 600	267,00	AB68495401	40 / 1320 / 1200	759,00
AB67820003	20 / 520 / 400	158,00	AB68328003	28 / 920 / 800	340,00	AB68045000	45 / 520 / 400	485,00
AB3822000	20 / 720 / 600	230,00	AB67730000	30 / 320 / 200	199,00	AB68050000	50 / 520 / 400	639,00
AB68320003	20 / 920 / 800	222,00	AB68030003	30 / 520 / 400	239,00			

**OTWORNICE MONOLITYCZNE SDS-MAX**

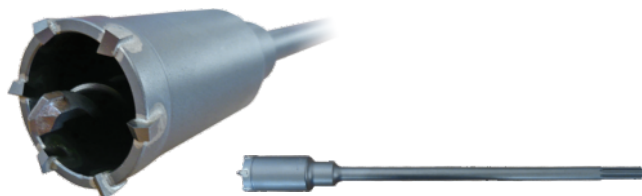

Nr artykułu	Ø / długość [mm]	Cena netto [zł]
AB73400050	50 / 550	546,32
AB73400068	68 / 550	646,67
AB73400080	80 / 550	724,72
AB73400090	90 / 550	825,06
AB73400100	100 / 550	880,81
AB73400000	pilot do otwornic monolitycznych 12 / 128	46,83

**DŁUTA SDS-MAX**

- podana cena netto [zł] za 1 sztukę dłuta
- 5 sztuk w opakowaniu  
(AB64600140, AB64600090,  
AB64645453 - 1 szt.)

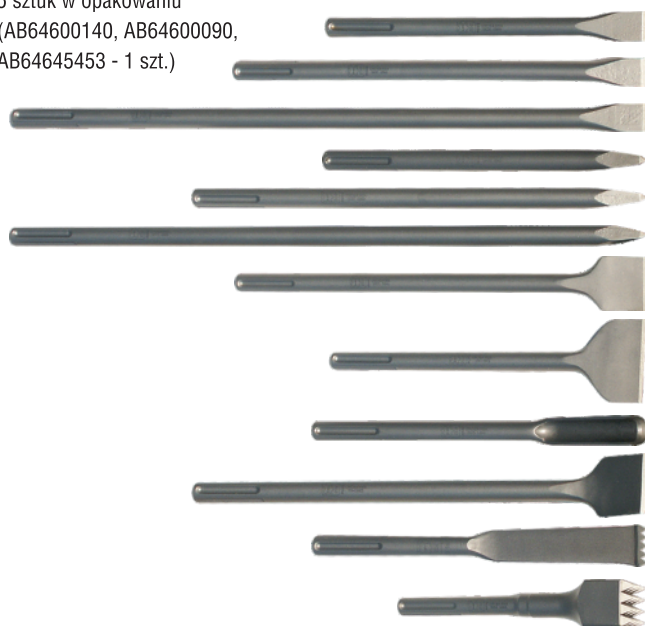

Nr artykułu	Typ	Wymiary [mm]	Cena netto [zł]
AB64600030	plaskie	280 x 24	29,57
AB64600010	szpic	280 x 24	29,57
AB64600040	plaskie	400 x 24	36,61
AB64600020	szpic	400 x 24	36,61
AB64600100	bruzdownica	300 x 25	66,95
AB64600050	szerokie	400 x 50	64,06
AB64600070	plaskie	600 x 25	61,17
AB64600110	szpic	600 x 25	61,17
AB64600060	przecinak łopatkowy	400 x 50	76,58
AB64600061	ekstra szerokie 75 mm	300 x 75	76,58
AB64600140	wycinak rowków	380 x 35	241,63
AB64600090	przecinak zębaty	300 x 32	238,86
AB64645453	młotek zębaty / groszkownik	45 x 45 x 240	143,71

**RATIO** system wiertel skręcanych



- unikalne rozwiązanie w skali światowej!
- różnorodność połączeń
- długość maksymalna do 1480 mm
- średnica wiercenia od 12 do 150 mm
- do młotowiertarek SDS-plus i SDS-Max

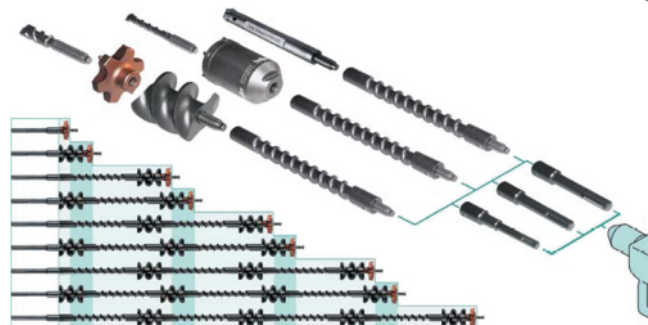

**GŁOWICA WIERTARSKA RATIO STARCUTTER**



Nr artykułu	Ø [mm]	Cena netto [zł]
AB68503500	35	329,00
AB68504200	42	399,00
AB68505200	52	499,00
AB68506500	65	649,00
AB68508000	80	759,00
AB68509000	90	959,00
AB68510000	100	1119,00
AB68511000	110	1169,00
AB68512500	125	1444,00
AB68515000	150	2049,00

**KORONA DO OTWORNICY RATIO QUICK**

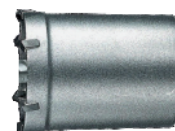

Nr artykułu	Ø [mm]	Cena netto [zł]
AB68950000	50	230,62
AB68965000	65	267,03
AB68968000	68	270,07
AB68980000	80	362,11
AB68990000	90	404,59
AB68991000	100	494,36
AB68991250	125	699,99
AB68915000	150	1350,99

**PILOT DO GŁOWICY WIERTARSKIEJ RATIO STARCUTTER**



Nr artykułu	Wymiary [mm]	Cena netto [zł]
AB68810000	18 x 125 / 50	62,69

**PILOT DO OTWORNICY RATIO QUICK**



Nr artykułu	Wymiary [mm]	Cena netto [zł]
AB68910230	12 x 155	44,78

**SPIRALA TRANSPORTOWA RATIO STARCUTTER**



Nr artykułu	Ø [mm]	Cena netto [zł]
AB68603200	32	199,00
AB68604700	47	239,00
AB68606300	63	289,00
AB68607800	78	399,00

**WIERTŁO DO ZBROJEŃ W BETONIE REBARCUTTER**

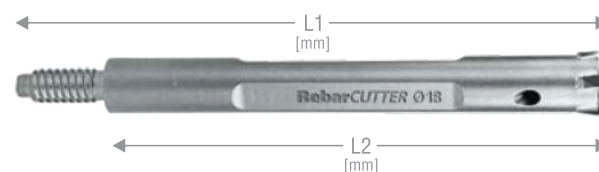

Nr artykułu	Ø / L1 / L2	Cena netto [zł]
AB69001200	12 / 190 / 230	325,00
AB69001400	14 / 190 / 230	329,00
AB69001600	16 / 190 / 230	369,00
AB69001800	18 / 190 / 230	369,00
AB69002000	20 / 190 / 230	399,00
AB69002500	25 / 190 / 230	469,00
AB69002800	28 / 190 / 230	485,00
AB69003000	30 / 190 / 230	549,00

**PRZEDŁUŻKA RATIO STARCUTTER**



Nr artykułu	Wymiary [mm]	Cena netto [zł]
AB68702500	25 x 280	185,00

**ADAPTERY RATIO**



Nr artykułu	Opis	Cena netto [zł]
AB68900000	SDS-Max, Ø 25 mm, dł. 185 mm	92,09
AB69663631	SDS-plus, Ø 19, dł. 108 mm	92,09

## wiertła do drewna

### WIERTŁA KLASYCZNE CV

- opakowanie z tworzywa sztucznego
- **podana cena netto [zł] za 1 sztukę wiertła**
- 1 sztuka w opakowaniu

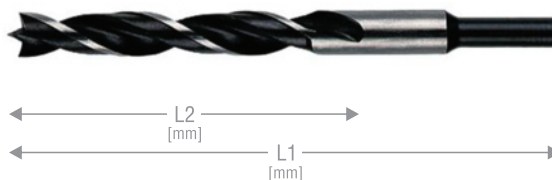

Nr artykułu	Ø / L1 / L2	Cena netto [zł]	Nr artykułu	Ø / L1 / L2	Cena netto [zł]	Nr artykułu	Ø / L1 / L2	Cena netto [zł]
AB80003000	3 / 61 / 33	2,68	AB80009000	9 / 120 / 81	4,66	AB80014000	14 / 151 / 96	11,99
AB80004000	4 / 75 / 43	3,03	AB80010000	10 / 133 / 87	6,63	AB80015000	15 / 160 / 100	13,97
AB80005000	5 / 86 / 52	3,38	AB80011000	11 / 142 / 89	8,73	AB80016000	16 / 160 / 100	15,83
AB80006000	6 / 93 / 57	3,61	AB80012000	12 / 151 / 96	9,43	AB80018000	18 / 180 / 120	24,68
AB80007000	7 / 109 / 69	4,42	AB80013000	13 / 151 / 96	11,06	AB80020000	20 / 200 / 130	32,01
AB80008000	8 / 117 / 75	4,07						

### KLASYCZNE CV - ZESTAW WIERTEŁ



Nr artykułu	Ø / L1	Cena netto [zł]
AB18000540	4 / 75, 5 / 86, 6 / 93, 8 / 117, 10 / 133	16,26

### POGŁĘBIACZ NASADOWY 90° HSS

- do użytku z wiertłami CV
- niedostępne bezpośrednio z magazynu - sprowadzane na zamówienie



Nr artykułu	Ø [mm]	Cena netto [zł]
AB80100300	3	30,83
AB80100400	4	30,83
AB80100500	5	30,83
AB80100600	6	30,83
AB80100800	8	30,83
AB80101000	10	30,83

### ŚWIDER SPIRALNY LEWIS

- opakowanie z tworzywa sztucznego
- **podana cena netto [zł] za 1 sztukę wiertła**
- 1 sztuka w opakowaniu

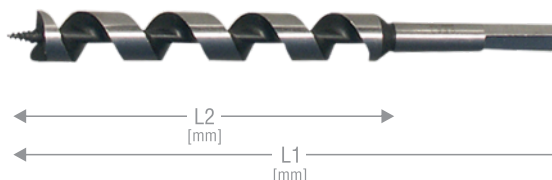

Nr artykułu	Ø / L1 / L2	Cena netto [zł]	Nr artykułu	Ø / L1 / L2	Cena netto [zł]	Nr artykułu	Ø / L1 / L2	Cena netto [zł]
AB83306000	6 / 230 / 155	14,26	AB83414000	14 / 460 / 385	32,81	AB83520000	20 / 600 / 530	76,56
AB83308000	8 / 230 / 155	16,28	AB83416000	16 / 460 / 385	37,73	AB83522000	22 / 600 / 530	90,01
AB83310000	10 / 230 / 155	17,15	AB83418000	18 / 460 / 385	41,84	AB83524000	24 / 600 / 530	109,58
AB83312000	12 / 230 / 155	18,11	AB83420000	20 / 460 / 385	47,66	AB83526000	26 / 600 / 530	119,91
AB83314000	14 / 230 / 155	19,36	AB83422000	22 / 460 / 385	56,70	AB83528000	28 / 600 / 530	138,58
AB83316000	16 / 230 / 155	21,58	AB83424000	24 / 460 / 385	67,73	AB83530000	30 / 600 / 530	155,03
AB83318000	18 / 230 / 155	22,25	AB83426000	26 / 460 / 385	74,26	AB83532000	32 / 600 / 530	166,57
AB83320000	20 / 230 / 155	27,55	AB83428000	28 / 460 / 385	80,78	mocowanie SDS-Plus - niedostępne bezpośrednio z magazynu - sprowadzane na zamówienie		
AB83322000	22 / 230 / 155	33,33	AB83430000	30 / 460 / 385	89,31			
AB83324000	24 / 230 / 155	42,96	AB83432000	32 / 460 / 385	99,84	AB83706000	6 / 230	23,33
AB83326000	26 / 230 / 155	51,63	niedostępne bezpośrednio z magazynu - sprowadzane na zamówienie			AB83708000	8 / 230	24,02
AB83328000	28 / 230 / 155	60,11				AB83710000	10 / 230	25,06
AB83330000	30 / 230 / 155	69,55	AB83508000	8 / 600 / 530	37,23	AB83712000	12 / 230	25,66
AB83332000	32 / 230 / 155	73,69	AB83510000	10 / 600 / 530	36,73	AB83714000	14 / 230	27,39
AB83406000	6 / 460 / 385	22,88	AB83512000	12 / 600 / 530	44,95	AB83716000	16 / 230	30,15
AB83408000	8 / 460 / 385	22,88	AB83514000	14 / 600 / 530	50,67	AB83718000	18 / 230	34,82
AB83410000	10 / 460 / 385	23,68	AB83516000	16 / 600 / 530	60,01	AB83720000	20 / 230	38,71
AB83412000	12 / 460 / 385	27,09	AB83518000	18 / 600 / 530	64,12	AB83722000	22 / 230	41,99

## SEDNIK DIN 7483

- opakowanie z tworzywa sztucznego
- **podana cena netto [zł] za 1 sztukę wiertła**
- 1 sztuka w opakowaniu



Nr artykułu	Ø / L1	Cena netto [zł]	Nr artykułu	Ø / L1	Cena netto [zł]	Nr artykułu	Ø / L1	Cena netto [zł]
AB81510000	10 / 90	10,64	AB81522000	22 / 90	16,91	AB81532000	32 / 90	22,96
AB81512000	12 / 90	11,27	AB81524000	24 / 90	18,26	AB81535000	35 / 90	24,73
AB81514000	14 / 90	12,21	AB81525000	25 / 90	18,89	AB81540000	40 / 90	29,12
AB81515000	15 / 90	12,73	AB81526000	26 / 90	19,10	AB81545000	45 / 90	36,11
AB81516000	16 / 90	13,25	AB81528000	28 / 90	21,39	AB81550000	50 / 90	37,88
AB81518000	18 / 90	15,03	AB81530000	30 / 90	21,81			
AB81520000	20 / 90	15,45						

## ŚRODKOWIEC DWUOSTRZOWY TCT (WIERTŁO FORSTNERA)

- niedostępne bezpośrednio z magazynu - sprowadzane na zamówienie
- **podana cena netto [zł] za 1 sztukę wiertła**
- 1 sztuka w opakowaniu



Nr artykułu	Ø / L1	Cena netto [zł]	Nr artykułu	Ø / L1	Cena netto [zł]	Nr artykułu	Ø / L1	Cena netto [zł]
AB82715000	15 / 90	40,91	AB82724000	24 / 90	73,16	AB82735000	35 / 90	94,97
AB82716000	16 / 90	49,47	AB82725000	25 / 90	76,29	AB82740000	40 / 90	114,17
AB82718000	18 / 90	54,06	AB82726000	26 / 90	78,58	AB82745000	45 / 90	140,26
AB82720000	20 / 90	59,28	AB82730000	30 / 90	86,10	AB82750000	50 / 90	166,35
AB82722000	22 / 90	63,76						

## WIERTŁO SZALUNKOWE HSS

- **podana cena netto [zł] za 1 sztukę wiertła**
- 1 sztuka w opakowaniu

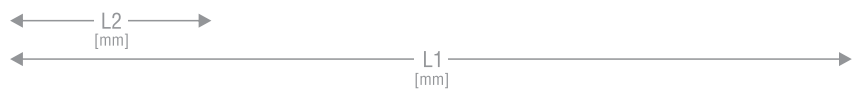

Nr artykułu	Ø / L1 / L2	Cena netto [zł]	Nr artykułu	Ø / L1 / L2	Cena netto [zł]	Nr artykułu	Ø / L1 / L2	Cena netto [zł]
AB84006000	6 / 400 / 57	24,09	AB84012000	12 / 400 / 101	33,05	AB84018000	18 / 400 / 100	54,56
AB84008000	8 / 400 / 75	24,74	AB84014000	14 / 400 / 108	37,76	AB84020000	20 / 400 / 100	65,64
AB84010000	10 / 400 / 87	27,51	AB84016000	16 / 400 / 100	42,37	AB84022000	22 / 400 / 100	84,47

## WIERTŁO PIÓRKOWE Z TRZPIENIEM E 6,3

- **podana cena netto [zł] za 1 sztukę wiertła**
- 1 sztuka w opakowaniu



Nr artykułu	Ø / L1	Cena netto [zł]	Nr artykułu	Ø / L1	Cena netto [zł]	Nr artykułu	Ø / L1	Cena netto [zł]
AB80608000	8 / 155	5,12	AB80619000	19 / 155	7,02	AB80628000	28 / 155	9,83
AB80610000	10 / 155	5,42	AB80620000	20 / 155	7,02	AB80630000	30 / 155	10,34
AB80612000	12 / 155	5,82	AB80622000	22 / 155	7,63	AB80632000	32 / 155	10,74
AB80613000	13 / 155	5,82	AB80624000	24 / 155	8,13	AB80636000	36 / 155	12,34
AB80614000	14 / 155	5,92	AB80625000	25 / 155	8,63	AB80638000	38 / 155	13,65
AB80616000	16 / 155	6,62	AB80626000	26 / 155	9,13			
AB80618000	18 / 155	7,02						

## PRZEDŁUŻKA DO WIERTEŁ PIÓRKOWYCH



Nr artykułu	Długość [mm]	Cena netto [zł]
AB80702700	270	29,57

### OTWORNICE BI-METALOWE HSS

- opakowanie z tworzywa sztucznego
- **podana cena netto [zł] za 1 sztukę otwornicy**
- 1 sztuka w opakowaniu



Nr artykułu	Ø [mm]	Cena netto [zł]	Nr artykułu	Ø [mm]	Cena netto [zł]	Nr artykułu	Ø [mm]	Cena netto [zł]
AB30014000	14	11,56	AB30041000	41	23,41	AB30079000	79	43,06
AB30016000	16	12,04	AB30044000	44	24,66	AB30083000	83	46,24
AB30017000	17	12,33	AB30046000	46	25,24	AB30086000	86	47,97
AB30019000	19	13,29	AB30048000	48	26,88	AB30089000	89	50,67
AB30020000	20	13,68	AB30051000	51	27,74	AB30092000	92	52,02
AB30021000	21	14,35	AB30054000	54	29,67	AB30095000	95	54,23
AB30022000	22	14,93	AB30057000	57	30,92	AB30098000	98	56,64
AB30024000	24	15,22	AB30060000	60	32,08	AB30102000	102	60,30
AB30025000	25	15,61	AB30064000	64	33,33	AB30105000	105	62,62
AB30027000	27	17,34	AB30065000	65	33,81	AB30108000	108	63,87
AB30029000	29	17,73	AB30067000	67	36,12	AB30114000	114	68,59
AB30030000	30	18,30	AB30068000	68	36,61	AB30121000	121	74,75
AB30032000	32	19,27	AB30070000	70	37,86	AB30127000	127	77,16
AB30035000	35	21,00	AB30073000	73	39,78	AB30140000	140	86,70
AB30038000	38	21,96	AB30076000	76	42,10	AB30152000	152	94,02
AB30040000	40	22,93						

### OTWORNICE BI-METALOWE HSS - ZESTAWY



Nr artykułu	Opis	Cena netto [zł]
AB30500000	Ø 19 / 22 / 32 / 35 / 40 / 51 / 54 mm 2 x uchwyt szybkomocujący, walizka	241,07
AB30510000	Ø 22 / 35 / 38 / 44 / 51 / 68 / 76 mm 2 x uchwyt szybkomocujący, walizka	264,91



### UCHWYTY I WIERTŁA DO OTWORNIC HSS



Nr artykułu	Opis	Cena netto [zł]
AB30302000	uchwyt ZE 2, 6-kąt Ø 14 - 30 mm	19,50
AB30305000	uchwyt ZE 5 „Quick-Release” Ø 32 - 152 mm	37,05
AB30306000	uchwyt ZE 6 SDS-Plus Ø 14 - 30 mm	23,48
AB30307000	uchwyt ZE 7 SDS-Plus Ø 32 - 152	40,18
AB30410000	wiertło pilot ZEB 1 długość 71 mm	9,91
AB30411000	wiertło pilot ZEB 2 długość 102 mm	14,09



## OTWORNICE UNIWERSALNE HM-TCT MULTI HOLE

- opakowanie z tworzywa sztucznego
- **podana cena netto [zł] za 1 sztukę otwornicy**
- 1 sztuka w opakowaniu



Nr artykułu	Ø [mm]	Cena netto [zł]	Nr artykułu	Ø [mm]	Cena netto [zł]	Nr artykułu	Ø [mm]	Cena netto [zł]
AB31016000	16	24,00	AB31040000	40	27,04	AB31070000	70	46,95
AB31019000	19	24,00	AB31044000	44	28,93	AB31073000	73	46,95
AB31020000	20	24,00	AB31051000	51	35,63	AB31076000	76	51,56
AB31022000	22	24,73	AB31054000	54	37,21	AB31080000	80	54,71
AB31025000	25	24,73	AB31057000	57	37,73	AB31082000	82	54,71
AB31027000	27	26,41	AB31060000	60	38,67	AB31092000	92	57,33
AB31029000	29	26,73	AB31064000	64	44,65	AB31102000	102	63,40
AB31030000	30	26,73	AB31065000	65	45,28	AB31105000	105	65,40
AB31032000	32	27,04	AB31067000	67	46,22	AB31114000	114	74,52
AB31035000	35	27,04	AB31068000	68	46,22	AB31125000	125	85,31
AB31038000	38	27,04						

## OTWORNICE HM-TCT MULTI HOLE - ZESTAWY



Nr artykułu	Opis	Cena netto [zł]
AB31500000	Ø 19 / 22 / 32 / 35 / 40 / 51 / 54 2 x adapter, zapasowe wiertło pilot, walizka	309,18
AB31510000	Ø 22 / 35 / 38 / 44 / 51 / 68 / 76 2 x adapter, zapasowe wiertło pilot, walizka	330,14



## UCHWYTY I WIERTŁA DO OTWORNIC HM-TCT MULTI HOLE



Nr artykułu	Opis	Cena netto [zł]
AB31300110	uchwyt ZE 11 6-kąt z pilotem HSS Ø 14 - 30 mm	29,99
AB31300140	uchwyt ZE 14 6-kąt z pilotem HSS Ø 32 - 125 mm	38,25
AB31300150	uchwyt ZE 15 6-kąt z pilotem TCT Ø 32 - 125 mm	51,88
AB31301100	wiertło pilot ZEB 11 (HSS) do Ø 14 - 152 mm	12,58
AB31301200	wiertło pilot ZEB 12 (TCT) do Ø 14 - 152 mm	12,58



**CLASSIC ROUTER TYPE A TCT**

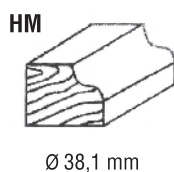
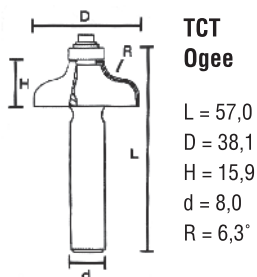

Nr artykułu	Rozmiar [mm]	Cena netto [zł]
AB98232006	38,1	74,26

**CLASSIC ROUTER TYPE B TCT**

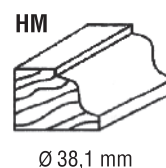
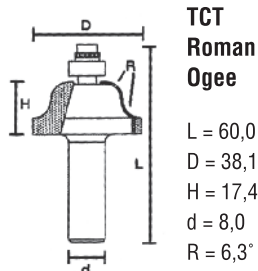

Nr artykułu	Rozmiar [mm]	Cena netto [zł]
AB98231006	38,1	73,95

**BEADING BIT TCT**

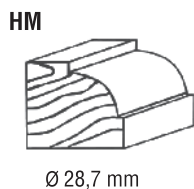
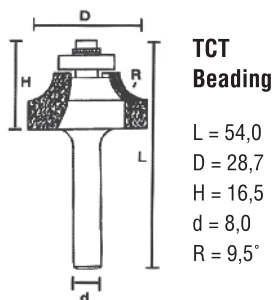

Nr artykułu	Rozmiar [mm]	Cena netto [zł]
AB98190063	25,4	56,36
AB98190095	28,7	61,61

**RABBETING BIT TCT**

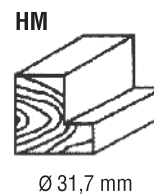
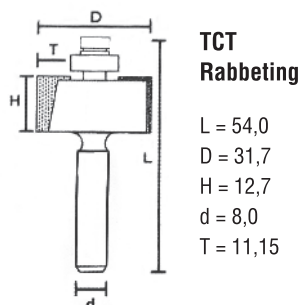

Nr artykułu	Rozmiar [mm]	Cena netto [zł]
AB98235032	31,7	66,86

**CORNER ROUNDING BIT TCT**

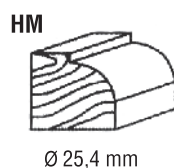
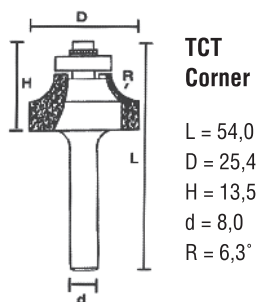

Nr artykułu	Rozmiar [mm]	Cena netto [zł]
AB98180063	25,4	56,36
AB98180095	28,7	61,61

**DOVETAIL BIT TCT**

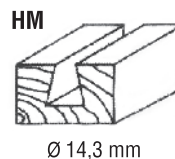
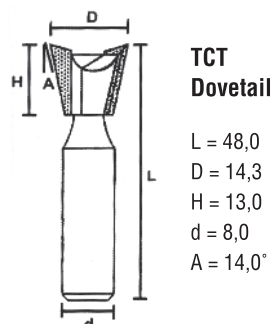

Nr artykułu	Rozmiar [mm]	Cena netto [zł]
AB98170143	14,3	44,74

**V-GROOVING BIT TCT**

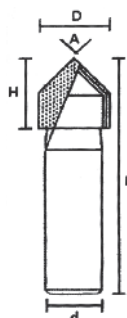

**TCT  
V-Groove**

L = 45,0  
D = 14,0  
H = 14,0  
d = 8,0  
A = 60°



HM  
Ø 14,0 mm

Nr artykułu	Rozmiar [mm]	Cena netto [zł]
AB98223011	14,0	28,93

**CORE BOX BIT TCT**

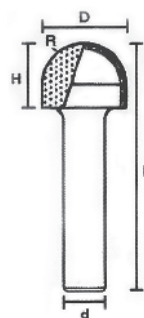

**TCT  
Core Box**

L = 40,0  
D = 12,7  
H = 9,5  
d = 8,0  
R = 6,3°



HM  
Ø 12,7 mm

Nr artykułu	Rozmiar [mm]	Cena netto [zł]
AB98200063	12,7	35,48

**STRAIGHT BIT TCT**

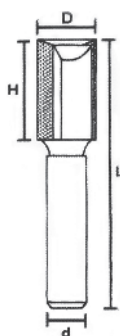

**TCT  
Straight**

L = 48,0  
D = 5,0  
H = 16,0  
d = 8,0



HM  
Ø 5,0 mm

Nr artykułu	Rozmiar [mm]	Cena netto [zł]
AB98222005	5,0	26,84
AB98222006	6,0	26,84
AB98222008	8,0	30,99
AB98222010	10,0	31,99
AB98222012	12,0	33,32
AB98222014	14,0	49,99
AB98222016	16,0	54,99
AB98222018	18,0	69,99
AB98222020	20,0	70,99

**tarcze do pił**

**TARCZE TCT DO PIŁ**



Nr artykułu	Opis	Cena netto [zł]
AB46501622	BASIC, 160 x 2,6 x 20 / 16 mm, 20 ATB	59,86
AB46501902	BASIC, 190 x 2,8 x 20 / 16 mm, 30 ATB	75,91
AB46502133	BASIC, 210 x 2,8 x 30 / 25 mm, 30 ATB	84,13
AB46502532	BASIC, 250 x 3,2 x 30 / 25 / 20 mm, 24 ATB Anti kickback	102,24
AB46503028	300 x 3,2 / 2,2 x 30 mm, 28 ATB Anti kickback	107,07
AB46601601	PROFI, 160 x 2,6 x 20 / 16 mm, 24 ATB	83,72
AB46601902	PROFI, 190 x 2,8 x 20 / 16 mm, 30 ATB	99,67
AB46602101	PROFI, 210 x 2,8 x 30 / 25 mm, 34 ATB	103,88
AB46602501	PROFI, 250 x 3,2 x 30 / 25 / 20 mm, 42 ATB	147,80
AB46603020	300 x 3,2 x 30 mm, 20 TZ (drewno z gwoździami)	114,99
AB46701601	PREMIUM, 160 x 2,6 x 20 / 16 mm, 48 ATB	131,96
AB46701902	PREMIUM, 190 x 2,8 x 20 / 16 mm, 56 ATB	149,96
AB46702101	PREMIUM, 210 x 2,8 x 30 / 25 mm, 64 ATB	166,93
AB46702501	PREMIUM, 250 x 3,2 x 30 / 25 / 20 mm, 80 ATB	192,85
AB46703048	300 x 3,2 x 30 mm, 48 ATB Precision	172,69
AB46703096	300 x 3,2 x 30 mm, 96 ATB Precision	239,96
AB46503532	350 x 3,5 / 2,5 x 30 mm, 32 ATB	159,00
AB46603524	350 x 3,5 / 2,5 x 30 mm, 24 TZ	159,00
AB46703554	350 x 3,5 / 2,5 x 30 mm, 54 ATB	222,00

- BASIC: mała ilość zębów TCT do szybkoobrotowego cięcia wszystkich materiałów drewnianych
- PROFI: uniwersalne piły do drewna, drewna z gwoździami, aluminium, laminatów, itp.
- PREMIUM: duża ilość zębów TCT do dokładnego i bardzo czystego cięcia materiałów drewnianych

**SZCZOTKA DOCZOŁOWA - DRUT SPLATANY**



Nr artykułu	Opis	Cena netto [zł]
AB99040010	Ø 65 mm, gwint M14	14,37
AB92031313	Ø 80 mm, gwint M14	22,18
AB92031317	Ø 100 mm, gwint M14	33,33
AB92031321	Ø 120 mm, gwint M14	40,02
AB99040012	Ø 65 mm, gwint M14, INOX	42,25

**SZCZOTKA DOCZOŁOWA - DRUT KARBOWANY**



Nr artykułu	Opis	Cena netto [zł]
AB90402253	Ø 60 mm, gwint M14	8,80
AB99010516	Ø 75 mm, gwint M14	10,70
AB94040513	Ø 80 mm, gwint M14	13,11
AB99010711	Ø 100 mm, gwint M14	15,49

**SZCZOTKA NA TRZPIENIU**



Nr artykułu	Opis	Cena netto [zł]
AB99420113	tarczowa, Ø 75 mm	4,67
AB99420112	tarczowa, Ø 100 mm	5,45
AB99428219	doczołowa, Ø 50 mm	4,67
AB99420027	doczołowa, Ø 75 mm	5,45
AB93220500	pędzelkowa, Ø 22 mm	4,97

**SZCZOTKA STOŻKOWA**



Nr artykułu	Opis	Cena netto [zł]
AB99049500	d. splatany, Ø 100 mm, M14	14,37
AB99019501	d. karbowany, Ø 100 mm, M14	14,37

**SZCZOTKA TARCZOWA - DRUT SPLATANY**



Nr artykułu	Opis	Cena netto [zł]
AB90440054	Ø 115 mm, otwór 22,2 mm	16,60
AB90416413	Ø 115 mm, otwór 22,2 mm, INOX	36,07
AB90416421	Ø 125 mm, otwór 22,2 mm	17,72
AB90416422	Ø 125 mm, otwór 22,2 mm, INOX	39,99

**SZCZOTKA TARCZOWA - DRUT KARBOWANY**



Nr artykułu	Opis	Cena netto [zł]
AB90406503	Ø 125 mm, otwór 22,2 mm	8,20
AB90406603	Ø 150 mm, otwór 22,2 mm	9,91
AB90406803	Ø 200 mm, otwór 22,2 mm	17,72

**SZCZOTKA RĘCZNA PLASTIKOWA**



Nr artykułu	Opis	Cena netto [zł]
AB41996457	1-rzędowa	5,45
AB41996492	1-rzędowa, INOX	7,68

**SZCZOTKA RĘCZNA DREWNIANA**



Nr artykułu	Opis	Cena netto [zł]
AB40930037	5-rzędowa	5,99